

Article number: 12318000060500
Description: KLEE-coil 318 000 060.500
M6 St. steel 1.4305 slotted pin

Measures

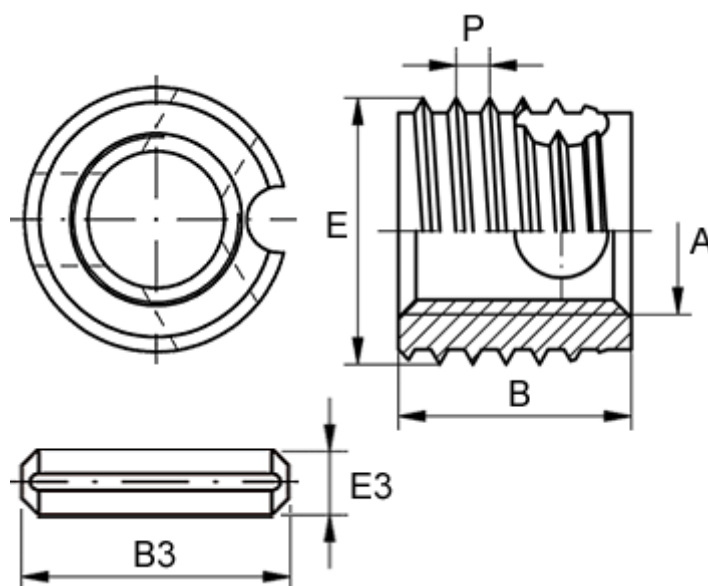

Female thread A	= M6
Length B	= 12
Male thread E	= 10.0
Min hole depth blind hole	= 15
Slotted pin B3	= 10
Slotted pin E3	= 2
Thread pitch P	= 1.25
Type	= 318 000 060 ...